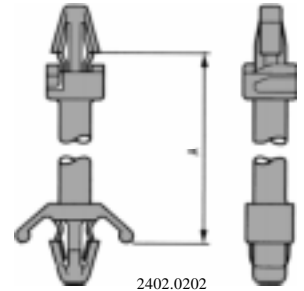
**BESTELNUMMER: OMSCHRIJVING****PRINTPLAAT (PCB) ACCESSOIRES
NYLON 6/6****PRINTPLAATAFSTANDHOUDER****ZELFKLEMMENDE**

printsteun met dubbele druk-in-bevestiging

A: (afstand tussen chassis en printplaat)

2402.0202	9.8 mm.
2402.0204	11.4 mm.
2402.0206	14.4 mm.
2402.0208	17.7 mm.
2402.0210	20.9 mm.
2402.0212	24.1 mm.
2402.0214	27.2 mm.
2402.0216	30.4 mm.
2402.0218	33.6 mm.
2402.0220	39.9 mm.
2402.0222	2.0 mm. (KGLS-1S)
2402.0224	16.6 mm. (KGLS-7S)

boorgat printplaat: 4.0 mm./boorgaat chassis: 4.8 mm.
max. dikte printplaat: 2.0 mm./chassis: 0.5-2.3 mm.

2402.0202

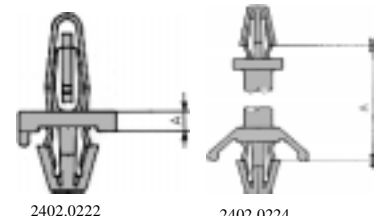

2402.0222

2402.0224

KLEMMENDE PRINTSTEUN**MET SCHROEFBEVESTIGING**

A: B: (schroefdiepte)

2402.0402	6.4	5.2 mm.
2402.0404	7.5	6.4 mm.
2402.0406	9.5	6.4 mm.
2402.0408	12.7	9.6 mm.
2402.0410	15.9	12.8 mm.
2402.0412	19.1	16.0 mm.
2402.0414	22.2	19.1 mm.
2402.0418	28.6	25.5 mm.
2402.0420	35.7	32.6 mm.

dikte printplaat: 1.6-2.0 mm.

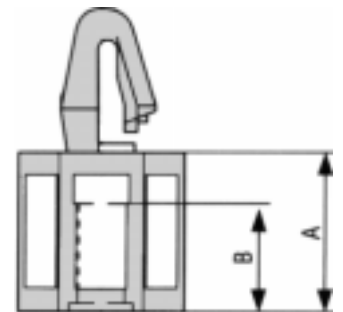

2402.0402

PRINTPLAAT ONDERSTEUNING**VOOR GROTE PCB'S**

printsteun met platte kop en druk-in-bevestiging

A:

2402.0602	7.5	mm.
2402.0603	8.2	mm.
2402.0604	9.1	mm.
2402.0606	12.1	mm.
2402.0608	15.4	mm.
2402.0610	18.6	mm.
2402.0612	21.8	mm.
2402.0614	24.9	mm.
2402.0616	28.1	mm.
2402.0618	31.3	mm.

boorgat chassis: 4,8 mm./chassisplaat: 0,5-2,3 mm.

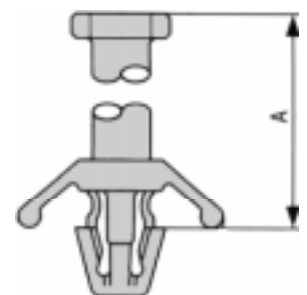

2402.0602

BESTELNUMMER: OMSCHRIJVING
PRINTPLAATAFSTANDHOUDER
ZELFKLEMMEND

printsteun met dubbele druk-in-bevestiging
afstandhouder en vergrendeling van PCB

A: (steunhoogte) B: (totale hoogte)

2402.0801	5.0 mm.	13.8 mm.
2402.0802	6.0 mm.	14.8 mm.
2402.0806	8.0 mm.	16.8 mm.
2402.0808	10.0 mm.	18.8 mm.
2402.0810	12.0 mm.	20.8 mm.
2402.0812	14.0 mm.	22.8 mm.
2402.0814	16.0 mm.	24.8 mm.
2402.0816	18.0 mm.	26.8 mm.
2402.0818	24.0 mm.	32.8 mm.

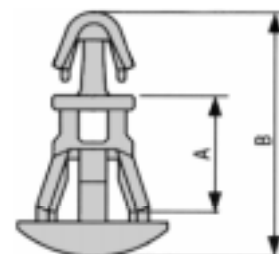

2402.0801

PRINTPLAATAFSTANDHOUDER
ZELFKLEMMEND

printsteun met korte druk-in-bevestiging en
vlakke draagkop voor een stabiele constructie

A: (steunhoogte) B: (totale hoogte)

2402.1001	5.0 mm.	8.0 mm.
2402.1002	6.0 mm.	8.9 mm.
2402.1006	8.0 mm.	10.9 mm.
2402.1008	10.0 mm.	12.9 mm.
2402.1010	12.0 mm.	14.8 mm.
2402.1012	14.0 mm.	16.9 mm.
2402.1013	16.0 mm.	18.9 mm.
2402.1014	18.0 mm.	20.9 mm.

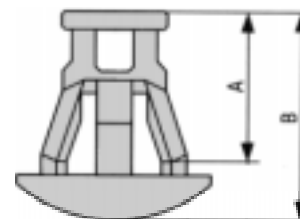

2402.1001

ZELFKLEMMENDE BEVESTIGING

voor printplaten en onderdelen
voor schroef M4,5/schroeflengte: D + 9,5 mm.
gatmaat 6.7*6.7 mm./A= 11.0 mm./ C= 9.7*9.7 mm.

B: (steunhoogte)

2402.1202	0.8 mm.
2402.1204	1.6 mm.
2402.1206	3.2 mm.
2402.1208	4.8 mm.
2402.1210	6.4 mm.

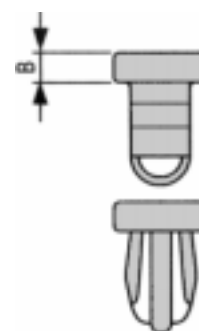

2402.1202

KNEVELBEVESTIGINGSKLEM

voor schroef M4/schroeflengte: C + 12.5 mm.
gatmaat 7.9*7.9 mm./A= 19.4 mm.

B: (steunhoogte)

2402.1250	0.8 mm.
2402.1252	3.2 mm.
2402.1254	4.8 mm.

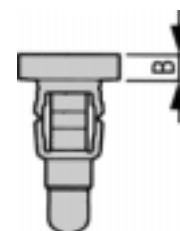

2402.1250

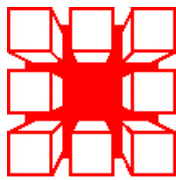
**DRACON**

KE KITAGAWA

BESTELNUMMER: OMSCHRIJVING**PRINTPLAATAFSTANDHOUDER**

ZELFKLEVEND

printsteun met enkele druk-in-bevestiging

	A:	B:	C:	
2402.1302	8.5	5.6	14.1	mm.
2402.1304	8.5	8.7	17.2	mm.
2402.1306	8.5	11.9	20.4	mm.

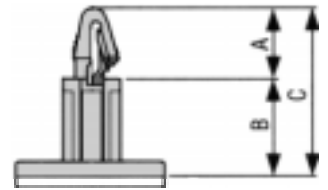

2402.1302

PRINTPLAATAFSTANDHOUDER

ZELFKLEMMEND VOOR HOUTEN CHASSIS

boorgat chassis: 6.0 mm. diepte: 8 mm.

boorgat printplaat: 4.0 mm. plaat: 1.6-2.3 mm.

2402.1350 steunhoogte: 6.4 mm.

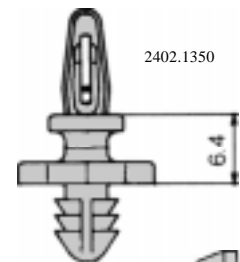

2402.1350

PRINTPLAATHOUDERS

SCHARNIEREND

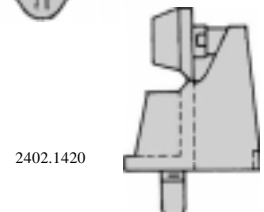
2402.1420 2 zijden zelfklemmend, materiaal: Polypropyleen
boorgat bodem: 2*4.0 mm. bodemplaat: 1,2 mm.
boorgat printplaat: 4.8 mm. plaatdikte: 1.6 mm.

2402.1420

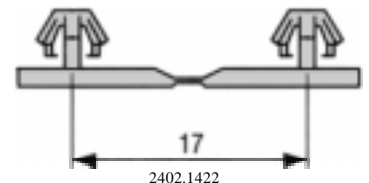
2402.1422 2 zijden zelfklemmend, materiaal: Nylon 6/6
boorgat bodem en printplaat: 4.0 mm.
plaatdikte 1.6 mm.

2402.1422

2402.1424 1 zijde zelfklemmend, materiaal: Nylon 6/6
bodem bevestiging met M3-schroef of drukrevet
met vergrendeling
boorgat printplaat: 4.0 mm. plaatdikte: 1.6 mm.

2402.1424

PRINTPLAAT-GELEIDER

2402.1802 voor printplaten van 1.6 mm.

chassisdikte: 0.8-2.0 mm.

chassisgatmaat: 5.5*5.5 mm.



2402.1802

Er zijn nog meer mogelijkheden om printplaten en accessoires te bevestigen en te steunen. Voor meer informatie en advies kunt U altijd contact opnemen met onze Sales Engineers, of natuurlijk de verkoop-binnendienst.



DRACON

KE KITAGAWA
BESTELNUMMER: OMSCHRIJVING
DRUKREVET
VOOR PRINTPLAATBEVESTIGING

snelle, makkelijke en permanente bevestiging

	A: (diameter)	B: (lengte)	T: (paneeldikte)
2402.2004	2.6	3.2	1.0-2.0
2402.2008	2.6	4.2	2.0-3.0
2402.2012	3.0	3.5	1.0-2.0
2402.2016	3.0	4.5	2.0-3.0
2402.2020	3.0	5.5	3.0-4.0
2402.2024	3.0	6.5	4.0-5.0
2402.2028	3.0	8.0	5.0-6.5
2402.2032	4.0	5.0	2.5-3.5
2402.2036	4.0	6.0	3.5-4.5
2402.2040	4.0	7.0	4.5-5.5
2402.2044	4.0	8.0	5.5-6.5
2402.2048	5.0	4.5	1.5-2.5
2402.2052	5.0	5.5	2.5-3.5
2402.2056	5.0	6.5	3.5-4.5
2402.2060	5.0	7.5	4.5-5.5
2402.2064	5.0	8.5	5.5-6.5
2402.2068	5.0	9.5	6.5-7.5
2402.2072	5.0	10.5	7.5-8.5
2402.2204	5.0	5.0	2.0-3.0
2402.2208	5.0	6.0	3.0-4.0
2402.2212	5.0	7.0	4.0-5.0
2402.2220	5.0	9.0	6.0-7.0
2402.2224	3.5	5.5	3.0-4.0

maten in mm.

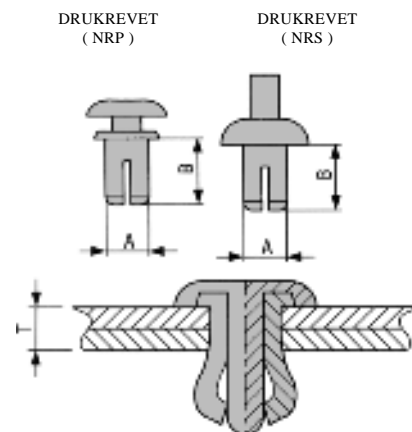
MINI-PRINTPLAATAFSTANDHOUDER

sterk draagvlak/ druk-in-bevestiging voor PCB

	A: (hoogte)	B:	gatmaat:
2402.2702	2.5	5.35	3.0
2402.2704	4.0	5.35	3.0
2402.2706	6.0	5.35	3.0
2402.2708	8.0	5.35	3.0
2402.2710	10.0	5.35	3.0
2402.2712	12.0	5.35	3.0
2402.2714	14.0	5.35	3.0
2402.2716	16.0	5.35	3.0
2402.2718	18.0	5.35	3.0
2402.2720	20.0	5.0	3.5
2402.2730	8.0	5.0	3.0

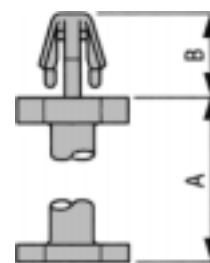

2402.2702

speciale verende constructie

maten in mm.

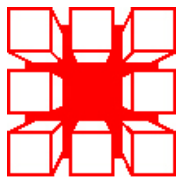
**DRACON**

KE KITAGAWA

BESTELNUMMER: OMSCHRIJVING**ABS BUS-AFSTANDHOUDER****MET SCHROEFBEVESTIGING**

combinatie van afstandhouder en sterke bevestiging
schroefbevestiging beschermd door ABS-materiaal
schroefkop (bushing) type NB-300
voor bout M3 - gatmaat: diam. 6,5 mm.

2402.2472

afstandbussen voor 2402.2472:

2402.2404 hoogte (A): 5.7 mm.
2402.2408 hoogte (A): 7.5 mm.
2402.2412 hoogte (A): 10.0 mm.
2402.2416 hoogte (A): 15.0 mm.
2402.2420 hoogte (A): 20.0 mm.

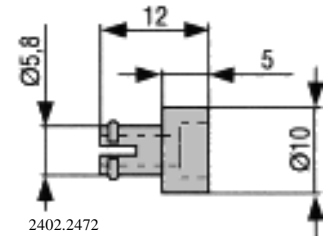

2402.2472

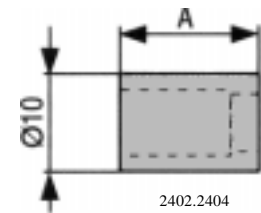

2402.2404

2402.2474

schroefkop (bushing) type NB-400
voor bout M4 - gatmaat: diam. 7.5 mm.

afstandbussen voor 2402.2474:

2402.2424 hoogte (A): 5.7 mm.
2402.2428 hoogte (A): 7.5 mm.
2402.2432 hoogte (A): 10.0 mm.
2402.2436 hoogte (A): 15.0 mm.
2402.2440 hoogte (A): 20.0 mm.

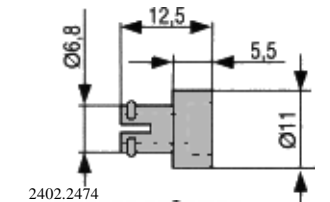

2402.2474

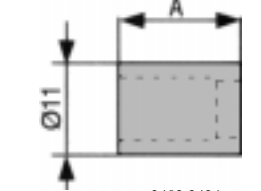

2402.2424

2402.2476

schroefkop (bushing) type TB-300
voor bout M3 - gatmaat: diam. 5.2 mm.

afstandbussen voor 2402.2476:

2402.2444 hoogte (A): 5.7 mm.
2402.2448 hoogte (A): 7.5 mm.
2402.2452 hoogte (A): 10.0 mm.
2402.2456 hoogte (A): 14.0 mm.
2402.2460 hoogte (A): 20.0 mm.
2402.2464 hoogte (A): 24.0 mm.

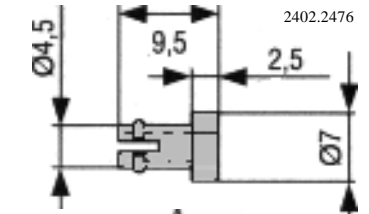

2402.2476

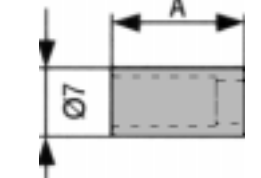

2402.2444

ZELFKLEMMENDE PRINTSTEUN**NYLON 6/6 NATUREL**

extra kort voor ruimtesparing-extra stabiel
voor plaatdikte: 1.6 mm.-gatmaat: diam. 4.0 mm.

A (steunhoogte): B (totale hoogte):

2402.2802 6.2 mm. 10.8 mm.
2402.2804 7.2 mm. 11.8 mm.
2402.2806 9.2 mm. 15.2 mm.
2402.2808 11.2 mm. 17.2 mm.
2402.2810 13.2 mm. 19.2 mm.
2402.2812 15.2 mm. 21.2 mm.
2402.2813 16.2 mm. 22.2 mm.
2402.2814 17.2 mm. 23.2 mm.
2402.2816 19.2 mm. 25.2 mm.
2402.2817 20.0 mm. 26.0 mm.
2402.2818 21.2 mm. 27.2 mm.
2402.2820 23.2 mm. 29.2 mm.

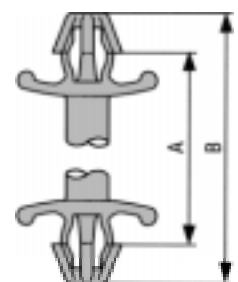

2402.2802

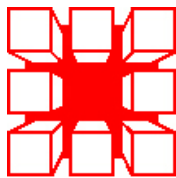
BESTELNUMMER: OMSCHRIJVING
ZELFKLEMMENDE PRINTPLAATHOUDER
MET SIMPELE ONTGRENDELING - TYPE KGES

aanbevolen om te gebruiken in combinatie met PHD
voor simpel omhooghalen of verwijderen van PCB
bij controle of reparatie van PCB

	A:	B:		
2402.2504	19.6 mm.	4.0 mm.		
2402.2506	21.6 mm.	6.0 mm.		
2402.2508	23.6 mm.	8.0 mm.		
2402.2510	25.6 mm.	10.0 mm.		
2402.2512	27.6 mm.	12.0 mm.		
2402.2514	29.6 mm.	14.0 mm.		
2402.2518	33.6 mm.	18.0 mm.		
2402.2525	40.6 mm.	25.0 mm.		
2402.2530	45.6 mm.	30.0 mm.		

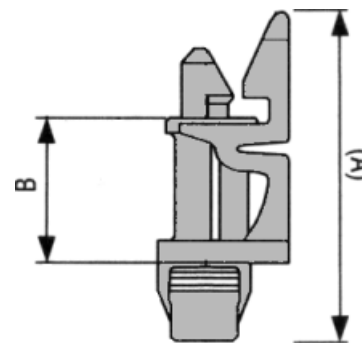

2402.2504

ZELFKLEMMENDE PRINTPLAATHOUDER
SCHARNIEREND - TYPE PHD

maakt omhoogdraaien van PCB mogelijk t.b.v.
controle van achterzijde v.d. printplaat

	A:	B:		
2402.2604	10.0 mm.	4.0 mm.		
2402.2606	12.0 mm.	6.0 mm.		
2402.2608	14.0 mm.	8.0 mm.		
2402.2610	16.0 mm.	10.0 mm.		
2402.2612	18.0 mm.	12.0 mm.		
2402.2614	20.0 mm.	14.0 mm.		
2402.2618	24.0 mm.	18.0 mm.		
2402.2625	31.0 mm.	25.0 mm.		
2402.2630	36.0 mm.	30.0 mm.		

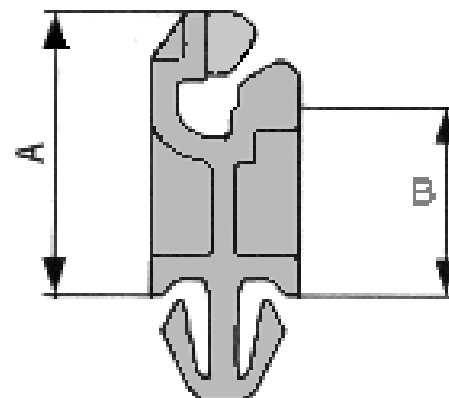

2402.2604

Geldend voor KGES en PHD:

gat bodemplaat: 5.5*5.5 mm.

bodemdikte: 1 - 1.8 mm.

gat printplaat: diam. 4.0 mm.

printplaatdikte: 1.6 mm.

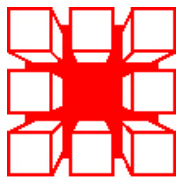
**BESTELNUMMER: OMSCHRIJVING****PRINTPLAATAFSTANDHOUDERS**

Nylon 66 (UL), klasse : 94V-2

Zelfklemmend tweezijdig

	Type:	maat A
2402.4403	LCA3- 3	3.2
2402.4411	LCA3-11	11.5
2402.4415	LCA3-15	15.2
2402.4420	LCA3-20	19.8
2402.4606	MCE- 6	6.35
2402.4608	MCE- 8	8.0
2402.4610	MCE-10	9.7
2402.4612	MCE-12	12.7
2402.4003	MCB- 3	3.2
2402.4006	MCB- 6	6.35
2402.4008	MCB- 8	8.2
2402.4010	MCB-10	10.5
2402.4012	MCB-12	12.7
2402.4015	MCB-15	15.7
2402.4019	MCB-19	19.1

2402.4403

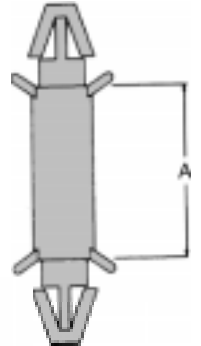

2402.4606

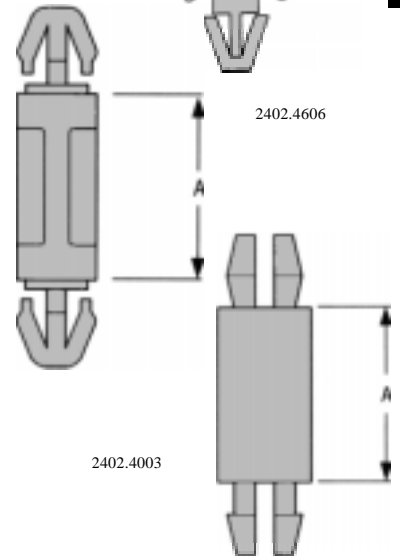

2402.4003

eenzijdig zelfklemmend + bodemplaat

	Type:	maat A	maat B	maat C
2402.4202	ACBS-5	5.0	1-1.2	0.8-1.4
2402.4204	ACBS-6	6.5	1-1.7	0.8-1.2
2402.4206	ACBS-6A	6.4	1-2.3	0.8-1.5
2402.4208	ACBS-6B	6.35	1-1.9	0.8-1.4
2402.4210	ACBS-6C	6.35	1-2.0	0.8-1.4
2402.4212	ACBS-8	8.0	1-1.8	0.8-1.4
2402.4214	ACBS-8A	8.0	1-1.9	1.6-2.2
2402.4216	ACBS-12	12.7	1-1.8	0.8-1.4

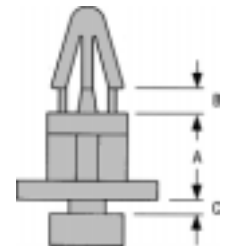

2402.4202

eenzijdig zelfklemmend + zelfklevende bodemplaat

	Type:	maat A
2402.4306	MS- 6	6.35
2402.4308	MS- 8	8.0
2402.4310	MS-10	9.6
2402.4312	MS-12	12.7
2402.4319	MS-19	19.4
2402.4322	MS-22	22.2

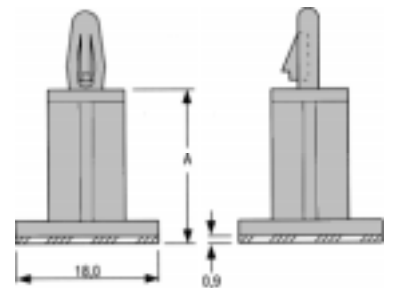

2402.4306

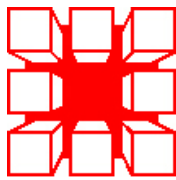
BESTELNUMMER: OMSCHRIJVING
PRINTPLAATAFSTANDHOUDERS

Nylon 66 (UL), klasse : 94V-2

eenzijdig zelfklemmend, bodempin met schroefdraad

	Type:	maat A	maat B	schroefdraad
2402.4806	SSBS-6	6.2	7.6	6/32
2402.4808	SSBS-6M	6.35	5.0	6/32
2402.4810	SSBS-10	9.4	7.5	6/32
2402.4812	SSBS-4-6	6.3	5.0	M 4
2402.4814	SSBS-4-10	10.0	7.4	M 4
2402.4816	SSBS-4-16	15.8	7.4	M 4

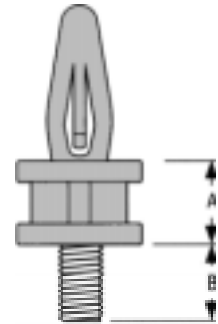

2402.4806

 eenzijdig zelfklemmend,
bodemplug voor houten panelen

	Type:	maat A
2402.4900	WCB-6	6.8

pluglengte: 7.7 mm/gat in houten paneel: \varnothing 6 mm

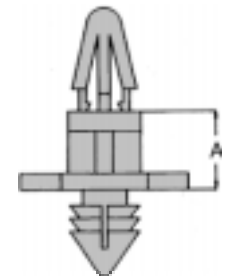

2402.4900

tweezijdig schroefbevestiging

	Type:	maat A
2402.4910	L-16	12.0

gat in chassis: \varnothing 3,5 mm, schroef: 3*14 mm

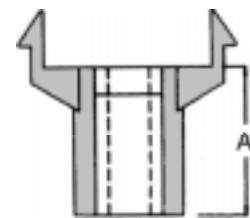

2402.4910

tweezijdig schroefbevestiging (M3)

	Type:	maat A	maat B	maat C
2402.5306	H- 6	6.35	5.5	3.0
2402.5308	H- 8	8.0	5.5	3.0
2402.5310	H-10	10.5	5.5	3.0
2402.5312	H-12	12.0	5.5	3.0
2402.5313	H-13	12.8	5.5	3.0
2402.5314	H-14	14.0	5.5	3.0
2402.5316	H-16	16.0	5.5	3.0
2402.5318	H-18	18.5	5.5	3.0
2402.5320	H-20	20.1	5.5	3.0
2402.5322	H-22	22.0	5.5	3.0
2402.5324	H-24	24.0	5.5	3.0
2402.5326	H-26	26.3	5.5	3.0
2402.5328	H-28	27.8	5.5	3.0
2402.5330	H-30	30.0	5.5	3.0

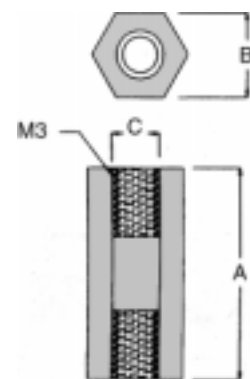

2402.5306

 Een meer uitgebreid overzicht van de PCB-accessoires
is op aanvraag verkrijgbaar.



DRACON

KE KITAGAWA

BESTELNUMMER: OMSCHRIJVING

PRINTPLAATGELEIDER

ZELFKLEMMEND

voor panelen tot 2,2 mm. dikte

makkelijke druk-in-bevestiging

boorgat paneel: diam. 3,8 mm.

materiaal: zwart Polycarbonaat (UL94V-2)

A: B: C: (=P1)

2403.0002

55

80

40

2403.0004

155

180

140

2403.0006

255

280

120 (C=P2)

2403.0008

95

120

80

maten in mm.

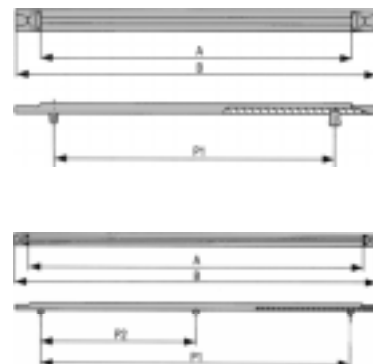

PRINTPLAAT VERWIJDERKLEM

voor panelen tot 1,6 mm. dikte

2403.0202

voor maten: zie afbeelding CBE-12

materiaal: Nylon 6 (UL94-2)

2403.0204

voor maten: zie afbeelding CBE-14

materiaal: POM (UL94HB)

2403.0008

voor maten: zie afbeelding CBE-2P

materiaal: PET (UL94V-0)

2403.0210

voor maten: zie afbeelding CBE-18

materiaal: Nylon 66 (UL94V-2)

2403.0204

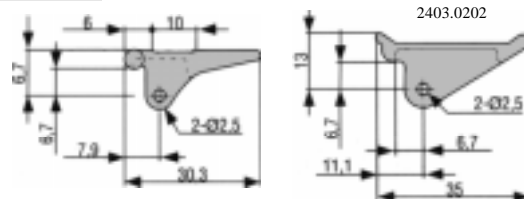

2403.0202

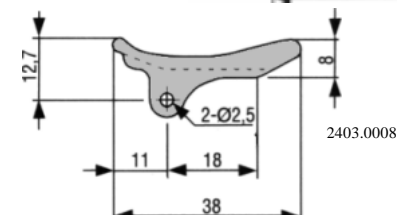

2403.0008

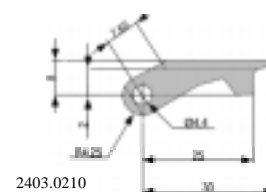

2403.0210

PRINTPLAATGELEIDER MET STOPPER

zelfklemmend, voorkomt slip door vibratie

voor printplaatdikte tot 1,6 mm.

in combinatie met NRP-355 voor middenstop en

CBE-15 als verwijderklem

2403.0010

voor maten: zie afbeelding GR-170SS

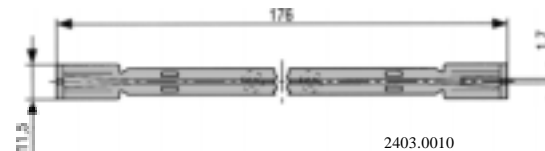

2403.0010

PRINTPLAAT VERWIJDERKLEM

speciaal voor geleider 2403.0010

2403.0206

voor maten: zie afbeelding CBE-15

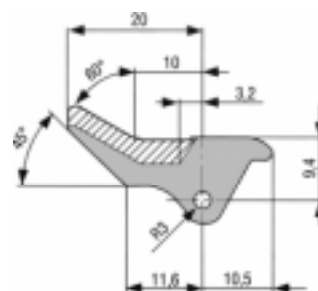

2403.0206

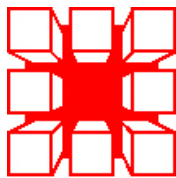
BESTELNUMMER: OMSCHRIJVING
LED-HOLDERS

 Nylon 66 (UL), klasse : 94V-2
 houders voor LED-indicators

	Type:	A-maat	B-maat	C-maat
2404.1010	LED- 5*3	5.5	7.4	6.4
2404.1012	LED- 8*3	8.0	7.4	9.0
2404.1014	LED-10*3	10.5	7.4	11.5
2404.1016	LED-16*3	16.1	7.1	16.1

	Type:	A-maat	B-maat
2404.1040	LED- 4*3A	4.0	5.0
2404.1050	LED- 5*3A	5.0	5.0

	Type:	A-maat
2404.1104	QLE- 4	4.0
2404.1105	QLE- 5	5.0
2404.1106	QLE- 6	6.0
2404.1107	QLE- 7	7.0
2404.1108	QLE- 8	8.0
2404.1109	QLE- 9	9.0
2404.1111	QLE-11	11.0
2404.1113	QLE-13	13.0
2404.1114	QLE-14	14.0
2404.1115	QLE-15	15.0

LED-HOUSING

	Type: (zwart)	A-maat
2404.1200	LED-2Y	3.0

	Type: (naturel)	A-maat
2404.1210	LED-10Y	10.0

	A:	B:	C:	D:	E:
2404.1303	2LED-3 10.0	5.1	10.1	5.0	4.5ø
2404.1305	2LED-5 12.0	5.5	11.0	6.2	4.6ø

LED-HOLDER (2 PIN)

Naturel Nylon 66(UL), klasse 94V-2

	Type:	A-maat	B-maat	C-maat
2404.1506	LED 3-6	6.1	4.1	3.5
2404.1509	LED 3-9	9.0	4.1	3.6
2404.1510	LED 3-9B	9.5	4.1	3.6
2404.1511	LED 3-11	11.1	4.1	3.5

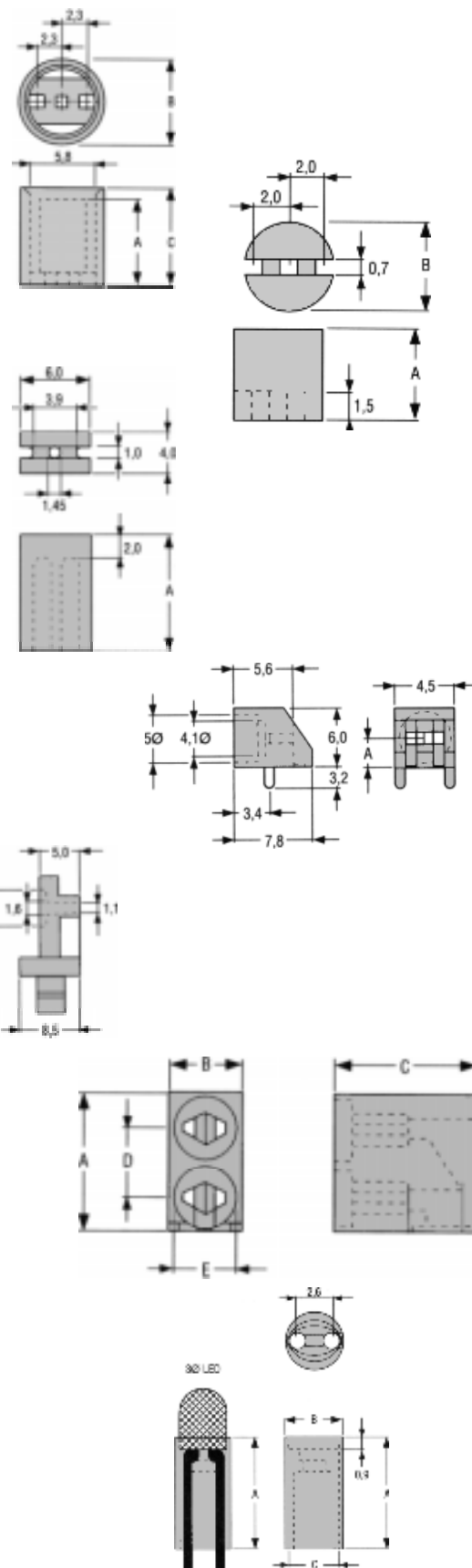

Uitgebreider overzicht LED-Holders op aanvraag verkrijgbaar